

# Duratuf<sup>®</sup> SENTRY SHEDS

## ASSEMBLY INSTRUCTIONS

### HNZSL2015



**BASE SIZE: 2.020m x 1.520m**

## CHECK OUT OUR ASSEMBLY VIDEO

Let Keith and Justin show you how to build your Sentry shed like a professional.

When used in conjunction with these assembly instructions, Keith's practical tips and tricks will make your assembly experience much simpler. Giving you visual guidance through sections that seem tricky on paper, and helping you achieve a flawless end result.

To view the video visit [www.duratuf.co.nz/sentry-assembly](http://www.duratuf.co.nz/sentry-assembly)



**Note:** Assembly video features a HNZSL1520. But can be used for reference for any other Sentry model.

# CONGRATULATIONS ON PURCHASING A DURATUF SENTRY SHED. BEFORE YOU BEGIN THE ASSEMBLY PLEASE NOTE SOME IMPORTANT POINTS:

## BEFORE YOU START:

- *Read all instructions carefully*
- *Identify all parts and check quantities against parts list*
- *Select a level site*
- *Do not mark cladding with pencil as lead can cause corrosion to cladding*

## SAFETY:

- *Do not attempt to build your shed in high winds*
- *Beware of sharp edges, recommend use of gloves*
- *Protect your eyes and ears*
- *For ease of assembly, use a friend to help*

## TOOLS REQUIRED:



**DRILL**



**RIVETER**



**SQUARE DRILL BIT**



**3.5mm DRILL BIT**



**LADDER**



**HAMMER**



**NAIL PUNCH**



**TAPE MEASURE**



**8mm HEX DRIVE**



**SKILL SAW**  
*(timber floor only)*

## WARRANTY REQUIREMENTS:







*Following are the minimum requirements for cladding used in Sentry Sheds.*

- *Wash all surfaces annually using a hose and soft nylon brush.*
- *Within 2 km of coast – wash every 3 months as above. After a storm, wash the cladding and the gutters as soon as possible to remove any highly corrosive salt deposits.*
- *Volcanic Ash Fallout – wash as soon as possible, removing fall out from roof and gutters.*
- *Do not allow manures, chemicals or other corrosive materials to have direct contact with cladding.*

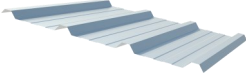
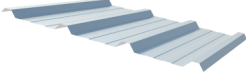
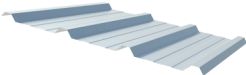
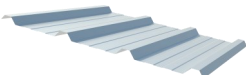
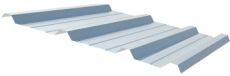
# HNZSL2015 PARTS LIST

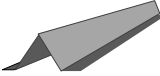
## CLADDING + FLASHING + HARDWARE





## PACK 1

DESCRIPTION	QTY	DIAGRAM	CHECKED
<i>Front Wall - 1.890m</i>	2		<input type="checkbox"/>
<i>Back Wall - 1.850m</i>	4		<input type="checkbox"/>
<i>Side Wall - 1.850m</i>	6		<input type="checkbox"/>
<i>Roof - 1.720m</i>	4		<input type="checkbox"/>
<i>Door Sheet Narrow - 1.850m</i>	2		<input type="checkbox"/>
<i>Door Sides - 1.850m</i>	2		<input type="checkbox"/>
<i>Door Jamb - 1.890m</i>	2		<input type="checkbox"/>
<i>Door Brace - 1.160m</i>	2		<input type="checkbox"/>
<i>Barge - 1.720m</i>	2		<input type="checkbox"/>
<i>Door Top/Bottom - 0.945m</i>	2		<input type="checkbox"/>
<i>Hardware Pack</i>	1		<input type="checkbox"/>
<i>Touchup Paint &amp; Brush</i>	1		<input type="checkbox"/>
<i>Checked:</i>		<i>Date:</i>	<input type="checkbox"/>

# HNZSL2015 PARTS LIST

## TIMBER PACK

## PACK 2

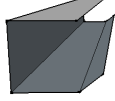
DESCRIPTION	QTY	DIAGRAM
<i>Front/Back Bottom Plates - H4 (Green)</i> 2.020 m	2	
<i>Back Top Plate - H1 (Red)</i> 2.020 m	1	
<i>Front Top Plate - H1 (Red)</i> 2.020 m	1	
<i>Side Wall Bottom Plates - H4 (Green)</i> 1.520m -	2	
<i>Side Wall Top Plates - H1 (Red)</i> 1.520m -	2	
<i>Spouting - 2.055m</i>	1	

# PARTS LOCATION

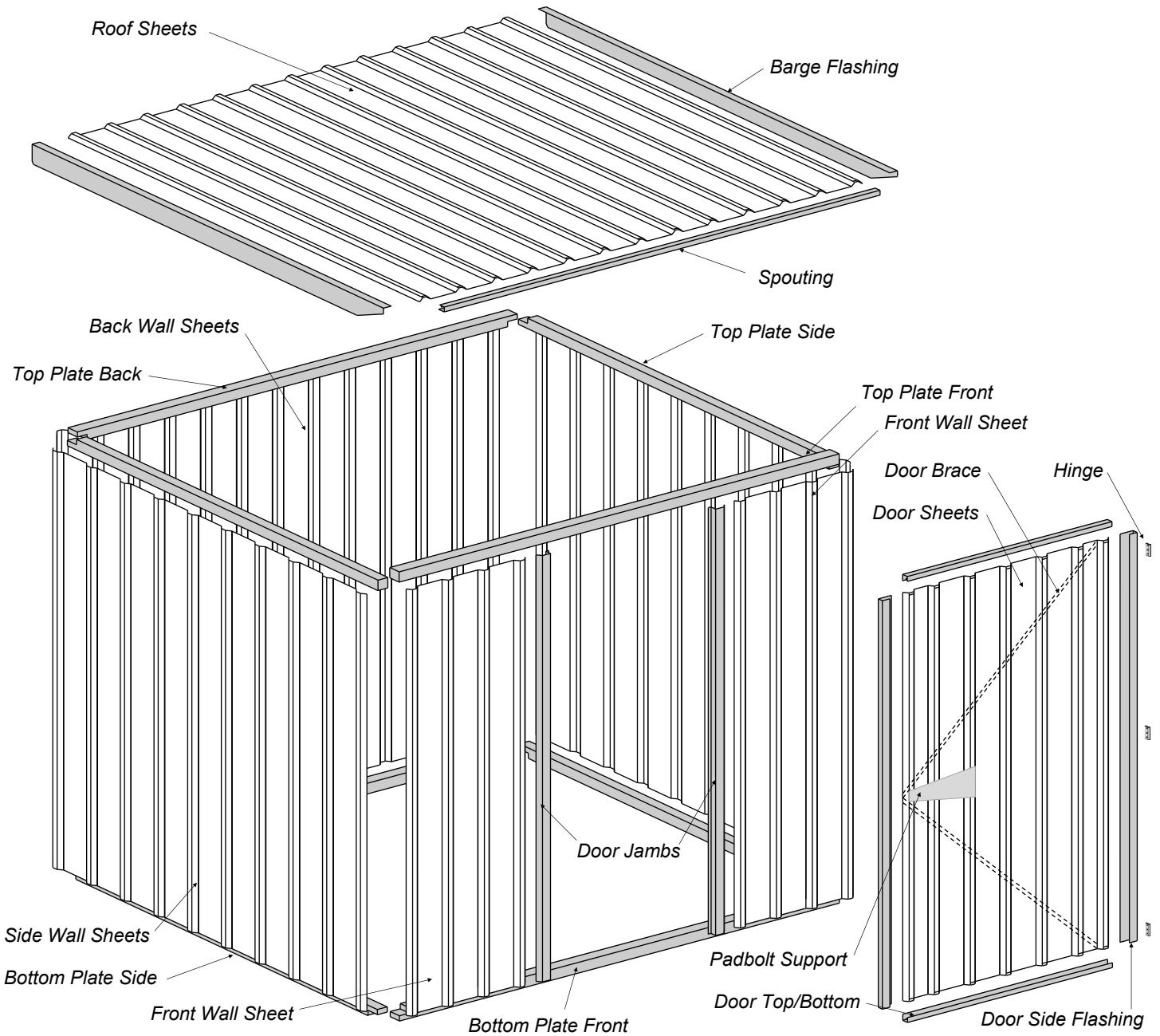

## QUICK OVERVIEW

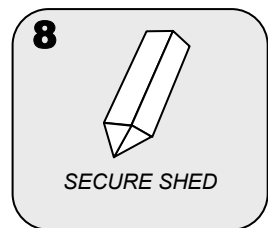
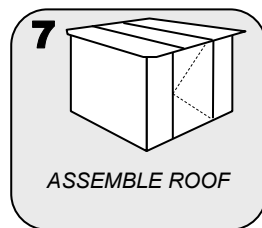
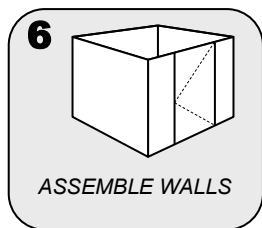
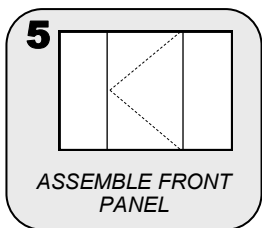
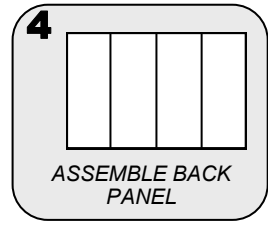
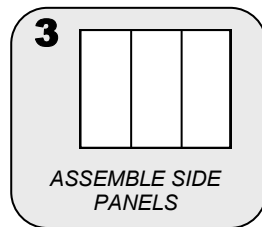
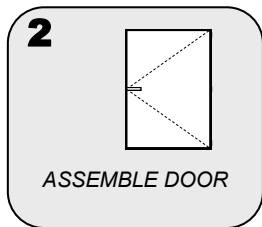
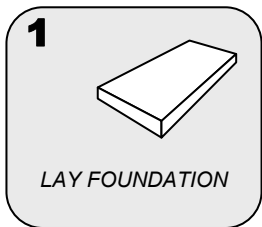



No doubt by now you will have decided what sort of base you are putting down.

Please read the section that applies to your situation.

If you choose to pour a concrete base you will need to decide whether you wish to raise the base plate of your shed. This allows the cladding to protrude below the surface of the concrete and ensures a water tight pad.

See concrete pad specifications below

By choosing this option you will need to make the pad to the specification below.

## RAISED BASE PLATE OPTION

(For sheds placed on a raised concrete floor)

- During construction, you may raise the bottom timber plate to allow the wall cladding to protrude 20mm below the bottom plate. This will stop water flowing between the bottom plate and the concrete floor.

See note on page 9.

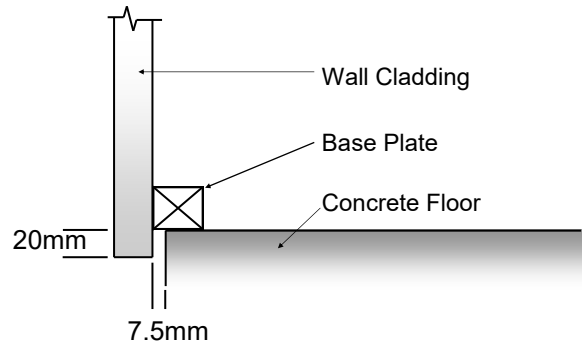

## CONCRETE SLAB FOR RAISED BASE PLATE SHED

To build a raised concrete slab for your shed to sit on, we recommend the following:

- The raised slab size should be 15mm smaller than the base size of the shed and at least 30mm above ground line.
- The slab should be 80mm thick in the middle and 100mm thick around the edges.
- The slab should be laid on a solid or compacted base.
- Plastic sheeting under slab will prevent moisture coming through from underneath.

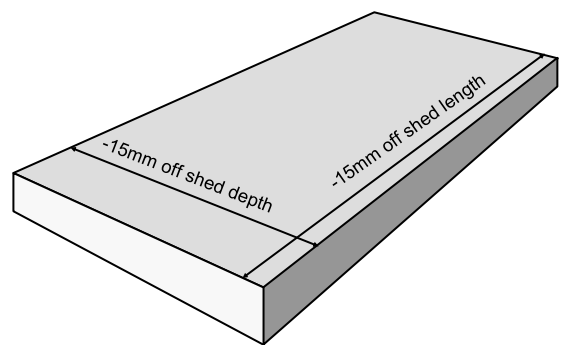

## SENTRY WOODEN FLOOR

- The optional Sentry kitset wooden floor is precut and designed to be fitted into the shed after the shed is assembled.
- Assemble shed as per instructions and fit floor last. (see page 14 for details).

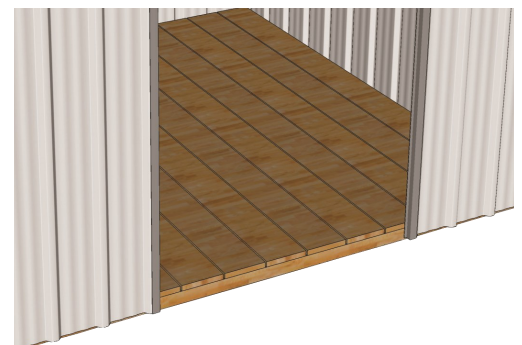



## SELECT:

- 2 x 1.850 m Door Sheets (Narrow)
- 2 x 0.945 m Door Top/Bottom Flashings
- 2 x 1.850 m Door Side Flashings
- 3 x Hinges
- 1 x Padbolt Support Flashing
- 2 x 1.160 m Door Brace Flashings
- 54 x Rivets

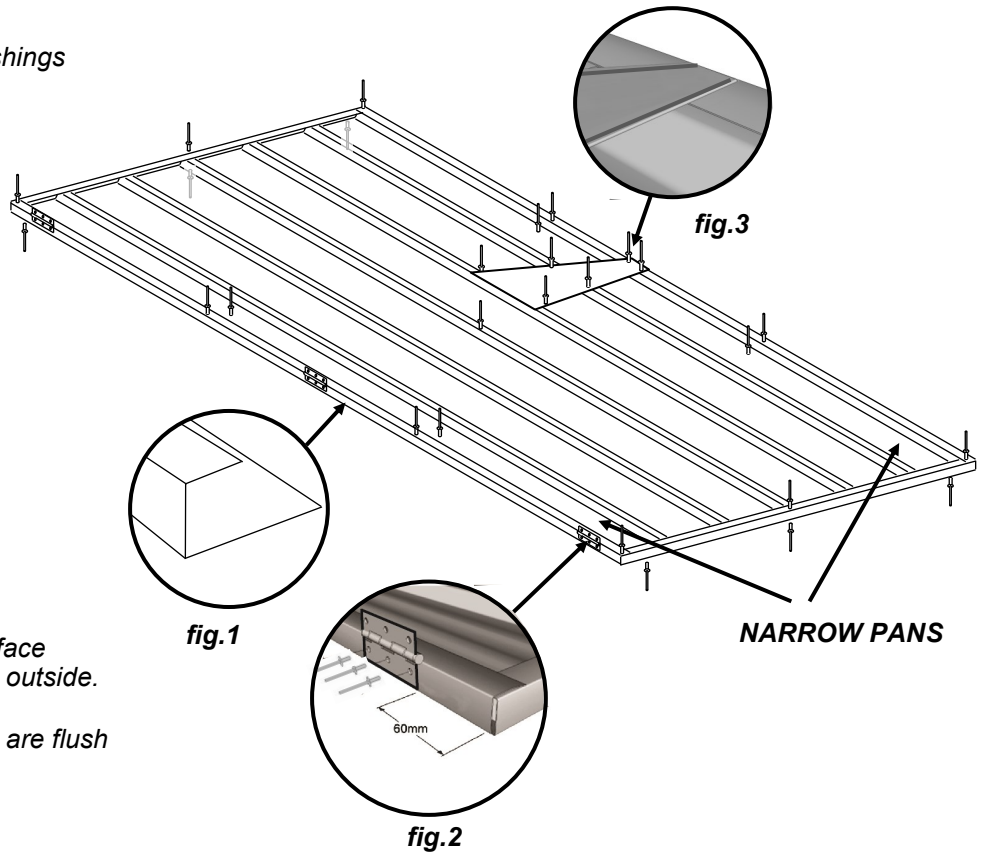

## STEP 1:

- Lay out 2 x door sheets on a flat surface making sure narrow pans are on the outside.
- Rivet sheets together ensuring ends are flush with each other.

## STEP 2:

- Position door side flashings and door top and bottom flashings and assemble door as shown, ensuring narrow face of flashing is on the front as per fig.1
- Drill and rivet as per diagram.

## STEP 3:

- Attach hinges to door side flashing using rivets provided. Ensure hinge is flush with back of door, and 60mm in from each end as per fig.2.
- Using six rivets, attach padbolt support as shown in fig.3.

## STEP 4:

- On the back of the door, place door braces in position as shown in fig.4.
- Ensure that the top and bottom ends of the braces are under the door flashings as shown in fig.5 and opposite ends of the braces overlap in the middle as shown in fig.6.
- Rivet door brace flashings onto back of door as shown. Where possible, rivet from front of door.

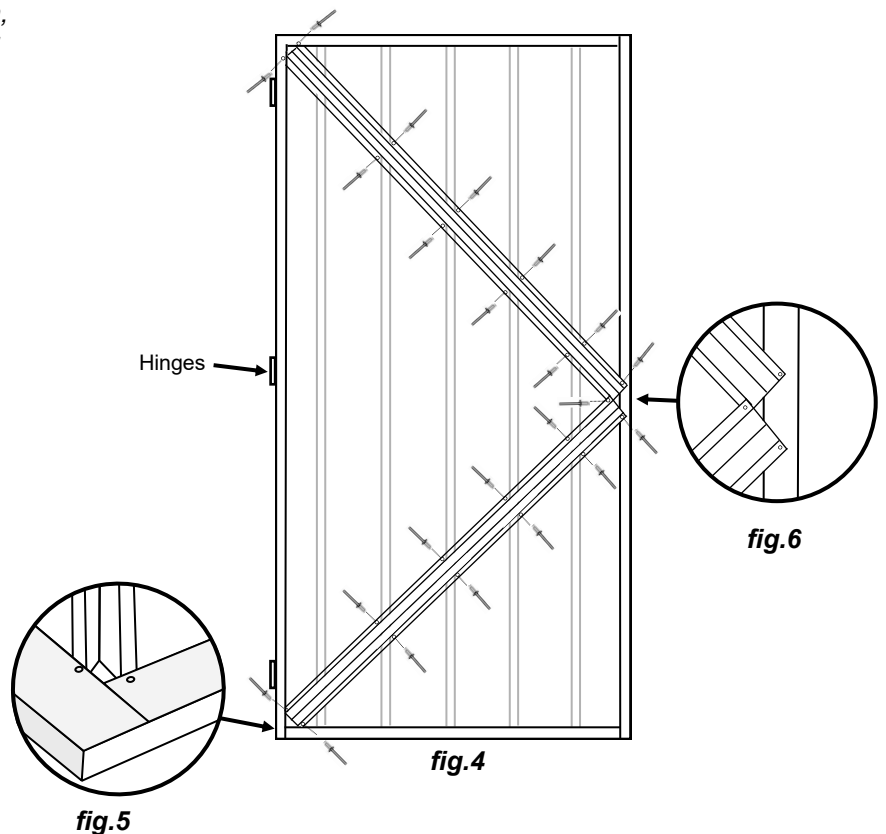



# ASSEMBLE SIDE PANELS



## SELECT:

- 6 x 1850 Wall Sheets
- 2 x 1.520 Top Plates (Red)
- 2 x 1.520 Bottom Plates (Green)
- 72 x 30mm Galv Clouts
- 8 x Rivets

## IMPORTANT—IF YOU CHOOSE TO RAISE YOUR TIMBER BASE PLATE –READ THE FOLLOWING;

For sheds with Raised Base Plate option only (see page 7), deduct 30mm from measurement shown between Top and Bottom Plates on all wall panels, so cladding protrudes 20mm below bottom plate.

## STEP 1:

- Lay out 1 x Top Plate and 1 x Bottom Plate on a flat surface as shown (corner cutouts to face outwards). **Measurements between Top and Bottom plates are critical to ensure wall panels fit together.**

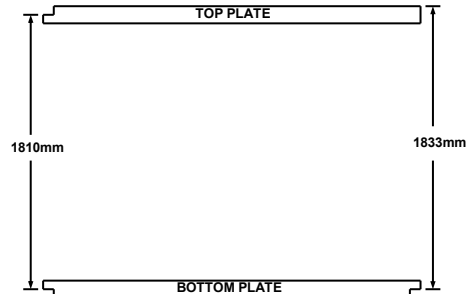

## STEP 2:

- Place 3 x 1.850 wall sheets on top of timber plates, with sheets flush with each other.
- Rivet sheets together on overlaps as shown.

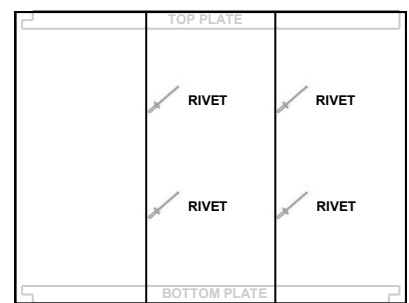

## STEP 3:

- Nail wall sheets to the Top Plate at each end making sure that the top of the sheets are flush with the top of the Top Plate and the sides of the wall sheet overhang the Top Plate by approx 15mm as shown.
- Check that the Top Plate is straight then nail along the wall sheet to the Top Plate, two clouts per pan (see fig. 1).

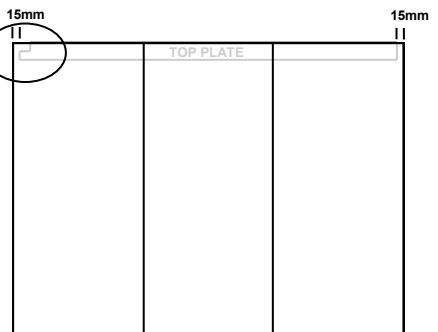
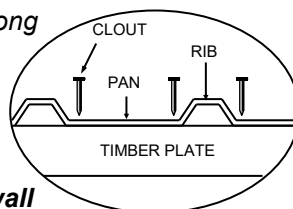
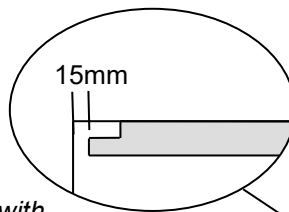

**Std Shed — Bottom Plate will protrude below wall sheet by approximately 10mm.**

fig.1

**Raised base plate shed — Wall sheet will protrude below the Bottom Plate by 20mm.**

## STEP 4:

- Nail the wall sheets to the Bottom Plate at each end ensuring each side of wall sheets overhangs the end of Bottom Plate by 15mm. Check that the distance between the Top and Bottom Plates is correct. (As per diagram in step 1)
- Check that the Bottom Plate is straight then nail the wall sheets to the Bottom Plate, two clouts per pan (see fig. 1).

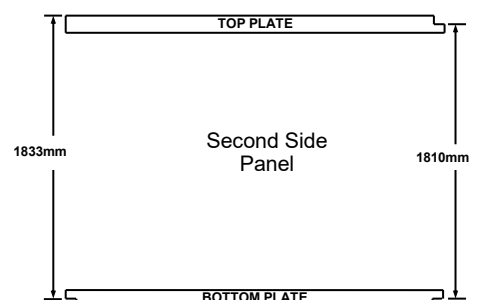
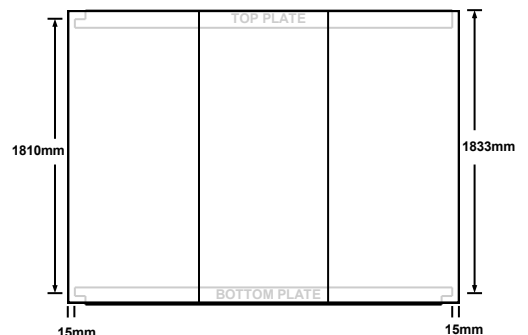

**Repeat with second side panel ensuring Top Plate is positioned in the OPPOSITE direction to the first side panel, as shown.**

# ASSEMBLE BACK PANEL



## SELECT:

- 4 x 1.850m Wall Sheets
- 1 x 2.020 m Top Plate (Red)
- 1 x 2.020 m Bottom Plate (Green)
- 48 x 30mm Galv Clouts
- 6 x Rivets

## IMPORTANT—IF YOU CHOOSE TO RAISE YOUR TIMBER BASE PLATE –READ THE FOLLOWING;

For sheds with Raised Base Plate option only (see page 7), deduct 30mm from measurement shown between Top and Bottom Plates on all wall panels, so cladding protrudes 20mm below bottom plate.

## STEP 1:

- Lay out 1 x Top Plate and 1 x Bottom Plate on a flat surface as shown (corner cutouts to face inwards).

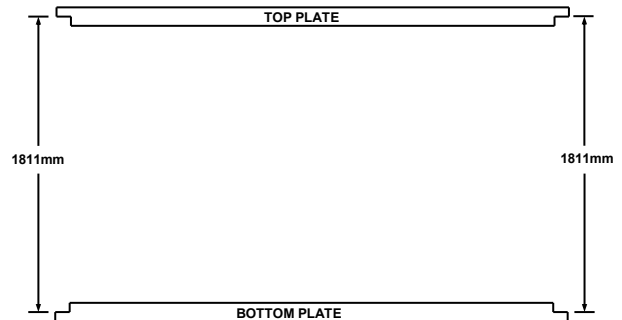

## STEP 2:

- Place 4 x 1.850 m wall sheets on top of timber Plates with bottom of sheets flush with each other.
- Rivet the sheets together on overlaps as shown.

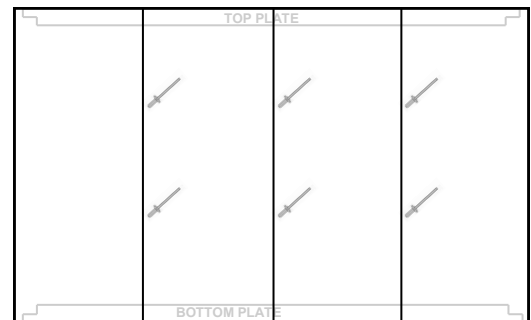

## STEP 3:

- Nail the wall sheets to the Top Plate at each end making sure that the top of the sheets are flush with the top of the Top Plate and that the sides of the wall sheets overhang the Top Plate by 15mm as shown.
- Check that the Top Plate is straight then nail wall sheets to the Top Plate, using two clouts per pan.

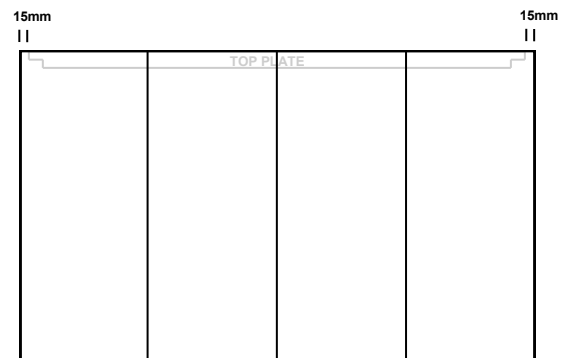

**Std Shed — Bottom Plate will protrude below wall sheet by approximately 10mm.**

**Raised base plate shed — Wall sheet will protrude below the Bottom Plate by 20mm.**

## STEP 4:

- Nail the wall sheets to the Bottom Plate at each end, ensuring that each side of the wall sheets overhangs the Bottom Plate by 15mm and that the distance between the Top and Bottom Plates is correct. (As shown)
- Check that the Bottom Plate is straight then nail wall sheets to the Bottom Plate, using two clouts per pan.

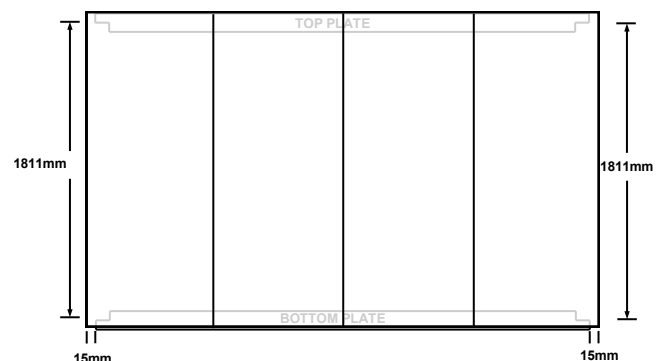

# ASSEMBLE FRONT PANEL

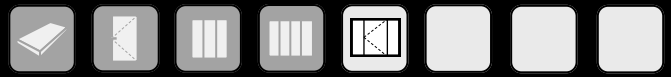

## SELECT:

- 2 x 1.890 Wall Sheets
- 1 x 2.020 Top Plate (Red)
- 1 x 2.020 Bottom Plate (Green)
- 2 x 1.890 Door Jamb Flashings
- 28 x 30mm Galv Clouts
- 17 x Rivets

## IMPORTANT—IF YOU CHOOSE TO RAISE YOUR TIMBER BASE PLATE –READ THE FOLLOWING;

For sheds with Raised Base Plate option only (see page 7), deduct 30mm from measurement shown between Top and Bottom Plates on all wall panels, so cladding protrudes 20mm below bottom plate.

## STEP 1:

- Lay out 1 x Top Plate and 1 x Bottom Plate on a flat surface as shown

**NOTE:** The Doorway is standard at 530mm from left-hand end. To shift the doorway to the right-hand side of the front wall, simply measure 530mm from the right-hand end.

## STEP 2:

- Using 2 x 30mm clouts, nail the Door Jamb Flashing flush with the top of the Top Plate at the correct measurement as shown in plan view. Pre drill holes using a 3.5mm drill bit
- Check the distance between the top and bottom plates then use a further 2 x 30mm clouts to nail the Door Jamb Flashings to the bottom Plate. Pre drill holes.

## STEP 3:

- Place 2 x Wall Sheets on timber plates. Ensure wall sheets fit underneath door jamb flashings.
- Ensure that the top of the sheet is flush with the top of the Top Plate and that the sides of the wall sheet overhang the Top Plate by 15mm as shown. Nail wall sheets to Top Plate (two clouts per pan)
- Nail the wall sheets to the Bottom Plate making sure that the Plates are the correct distance apart and that the sides of the wall sheets overhang the Bottom Plate by 15mm.
- Drill & rivet Door Jamb Flashings to wall sheets using four rivets equally spaced on each side.

**NOTE:** Door can be hinged on either side.

## STEP 4:

- Place the door on the panel (In open position, approx 20mm below top of top plate). Using two rivets, rivet the top and bottom hinges to the Door Jamb Flashing, ensuring door closes properly.
- Fit remaining rivets.

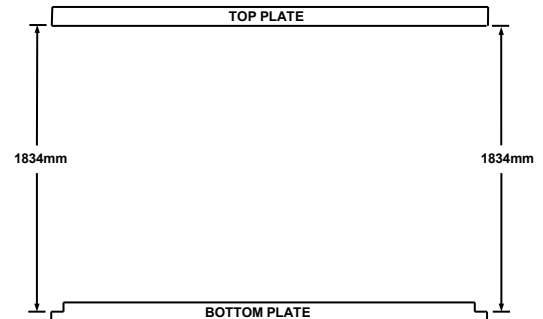

Plan View

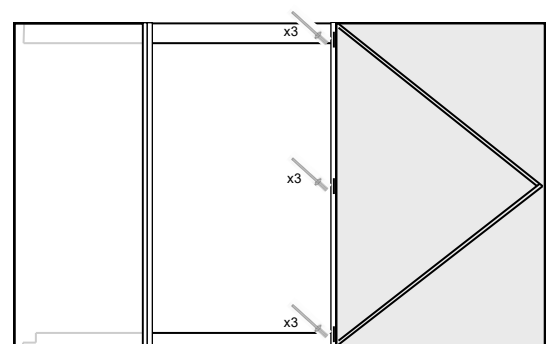
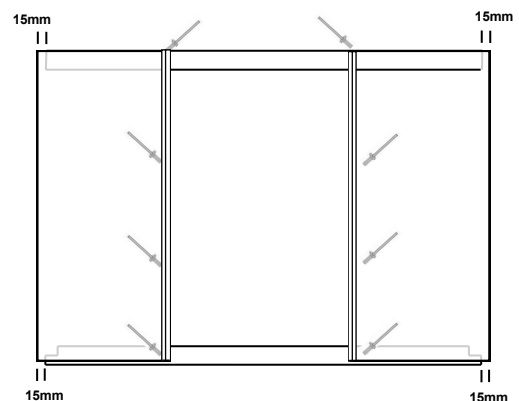
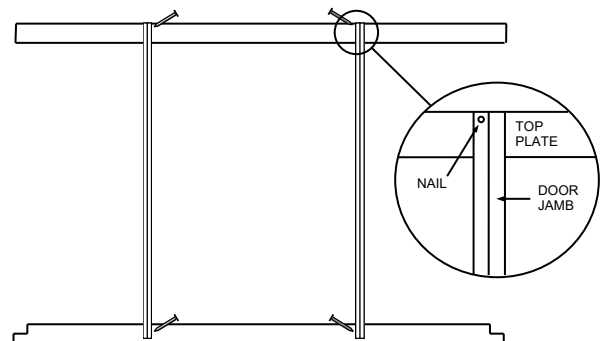
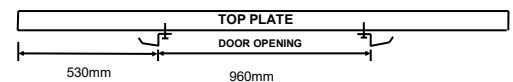



## SELECT:

- 4 x Pre-made Wall Panels
- 12 x 40mm Screws
- 4 x 75mm Screws
- 16 x Rivets

## STEP 1:

- Stand the Back Panel and the Side Panel up using someone to support the panels while they are screwed together.
- Before fixing, ensure that the Side Panel overlaps the Back Panel.
- Using 4 x 40mm screws (2 per join) screw the Top and Bottom Plates together in the corners.

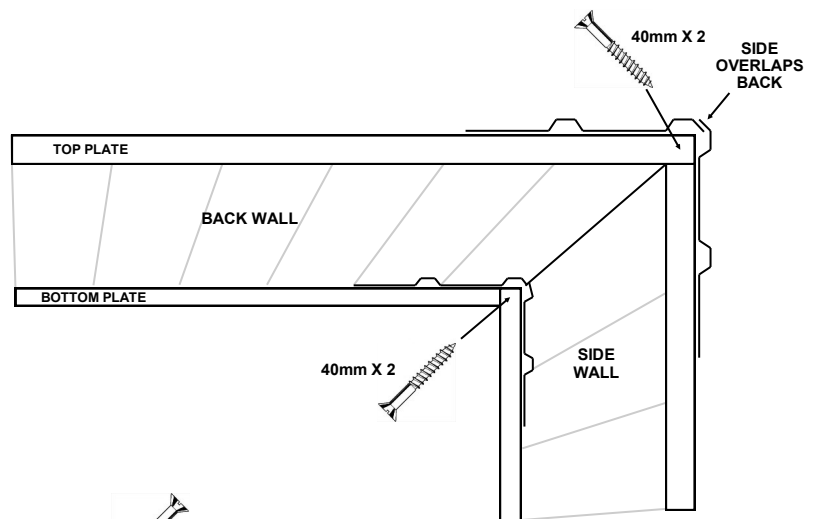

## STEP 2:

- Repeat Step 1 with the second Side Panel, ensuring that the Side Panel overlaps the Back Wall Panel.

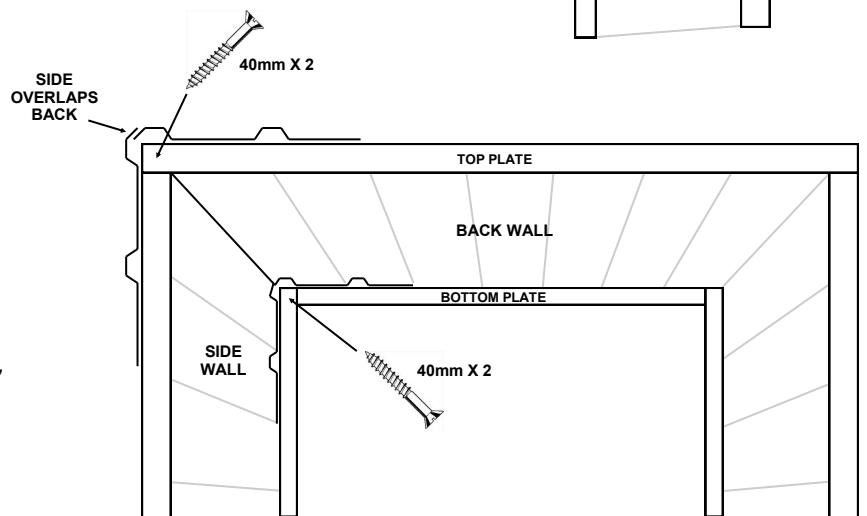

## STEP 3:

- Stand up the Front Wall Panel.
- Ensure that the Front Wall Sheets overlap the Side Wall Sheets.
- Using 4 x 75mm screws, screw the Top Plates together.
- Using 4 x 40mm screws, screw the Bottom Plates together.

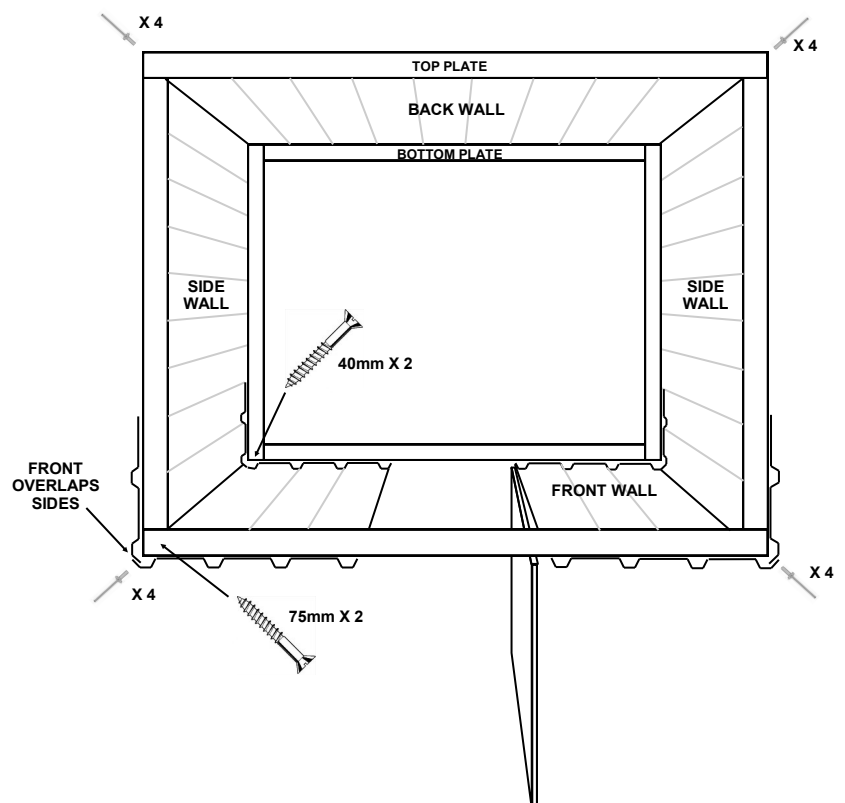

## STEP 4:

- Rivet the wall sheets together at the corners using 4 equally spaced rivets as shown.



## SELECT:

- 4 x 1.720 m Roof Sheets
- 1 x 2.055 m Spouting
- 2 x 1.720 m Barges
- 22 x 55mm Roofing Screws
- 27 x Rivets
- 4 x 50mm Clouts

## IMPORTANT

Use 50mm Clouts only on outside ribs covered by Barge flashings. Pre-drill holes using a 3.5mm drill bit. Use Roofing Screws on all other ribs. Ensure screws are not overtightened as this can damage the seals and cause the shed to leak.

## IMPORTANT—FOR SHEDS WITH OPTIONAL CLEAR ROOF PANEL

Assemble as below, making sure that the Clear Roof Sheets overlap the standard roof sheets on both sides. Pre drill and fasten with the 55mm roofing screws provided.

## STEP 1:

- Ensure Shed is sitting level and square.
- Lay Roof Sheets on the Top Plates.
- Rivet sheets together at overlaps with 2 x rivets per join.

## STEP 2:

- Position the Roof Sheets with front overhang of 130mm at each end (**fig. 1**).
- Using 4 x 50mm Clouts, pre-drill and nail the Roof Sheets to the Top Plates through the ribs, at each corner, ensuring ribs on the Roof Sheets line up with ribs on the Wall Sheets (**fig.2**).

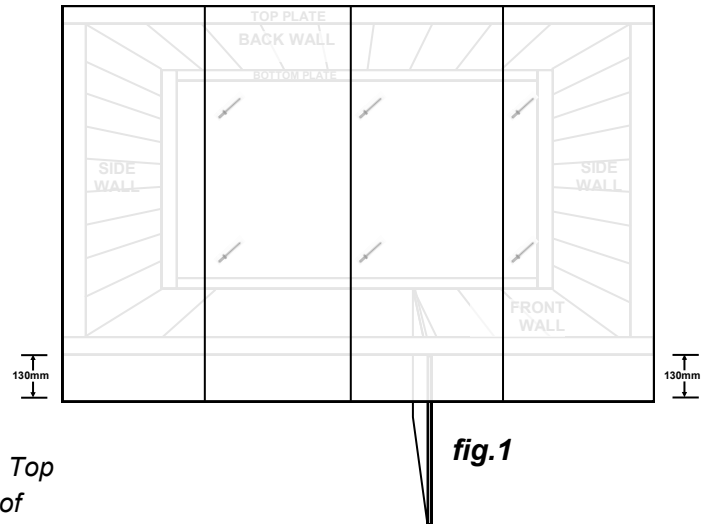

fig.1

## STEP 3:

- Ensure the Front and Back Top Plates are straight.
- Screw the roof sheets to the front & back Top Plates, using 1 x Roofing Screw per rib. (**fig.2**).

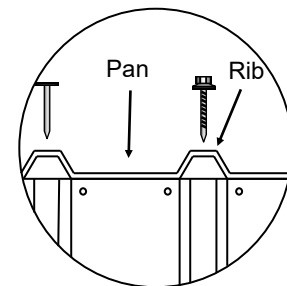

fig.2

## STEP 4:

- Place barge flashings on roof at end of shed ensuring the diagonal trimmed end is at the front. (See diagram on pg 6)
- Rivet the Barge Flashings to the roof and the side wall, using four rivets on top of barge and four into the side (**fig.3**).

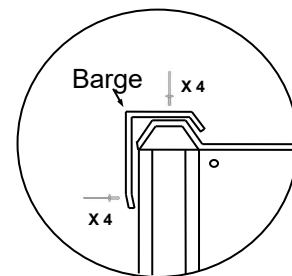

fig.3

## STEP 5:

- Place spouting in position and rivet to Barge Flashings at each end and rivet to roof sheets (1 rivet per 1 sheet) (**fig.4**).

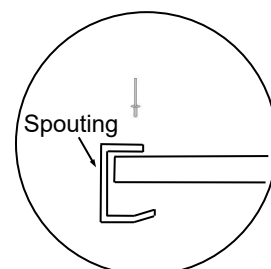

fig.4



Secure your shed using Treated Timber Pegs or a Bolt Down Kit

## TIMBER PEGS—WOODEN FLOOR

- The optional Duratuf Timber Peg Down Kit includes six H5 treated timber pegs that can be hammered into the ground and then attached to the Base Plate with stainless steel screws. A Sentry timber floor can then be fitted on top of the Base Plate.



## BOLT DOWN KIT—CONCRETE

- The optional Duratuf Bolt Down Kit includes 6 x galvanised brackets, screws and dynabolts.
- Space the brackets evenly around the shed and fix to the Bottom Plate and the concrete slab. A 10mm masonry drill bit is required.



## OPTIONAL SENTRY FLOOR

- Position the Floor Joists centrally between the side Base Plates and skew nail each end with two 75mm nails.
- Check that the shed is sitting level and square and that the diagonal Bottom Plate measurements are the same.
- Place the Floor Boards in position. (You may need to cut the last Floor Board to the correct width using a Skill Saw.) Nail each Floor Board in, using two 50mm nails each end and two nails into each floor joist.

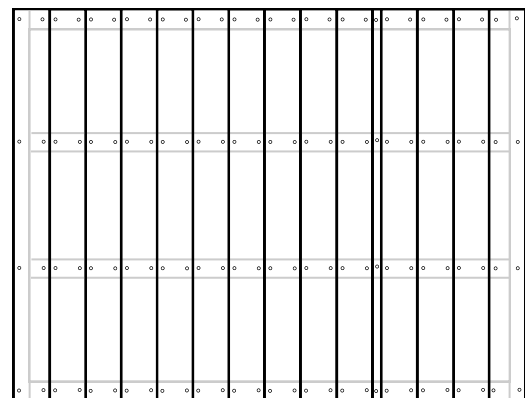
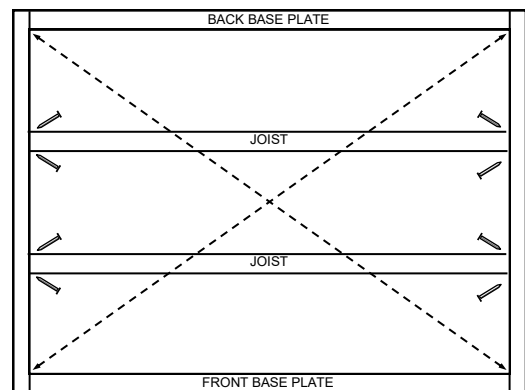

## FIT PADBOLT

- Rivet Padbolt to door and keeper onto Door Jamb as shown.



## IMPORTANT— CLEAN UP

REMOVE ALL DRILL FILINGS FROM ROOF, WALLS AND CHANNELS THOROUGHLY. FAILURE TO DO THIS WILL RESULT IN CORROSION AND COULD THEREFORE VOID THE WARRANTY.

**YOUR DURATUF SENTRY SHED IS NOW COMPLETE. RELAX.....**



## 25 YEAR WARRANTY

Riverlea Group Ltd warrant that the cladding used in the manufacture of the Sentry shed will not rust within 25 years from the date of purchase.

Any liability for product failure that may arise will be limited to repair or replacement of the defective product and will only apply for the benefit of the original purchaser. Riverlea Group Limited will not be liable for any consequential loss or damage, labour, or transport charges.

This warranty is conditional on:

- Construction, installation and maintenance being carried out as specified in the Assembly Instruction Manual.
- The shed being installed in modest inland corrosion zones or areas where the steel corrosion rate is less than 200g/m<sup>2</sup>
- Warranty certificate being returned to manufacturer within 21 days of purchase together with proof of purchase.

This warranty does not cover the following:

- Fastenings and fixings.
- Normal wear and tear, damage by impact or acts of God.
- Situations where the shed has been used for storage of chemicals, manure or corrosion causing products.
- Unauthorized modification of the structure, including painting of the cladding.

---

## WARRANTY REGISTRATION

Please visit <http://www.riverleagroup.co.nz/warranty-garden-sheds> to validate the Warranty on your shed. Click on the Warranty Registration Link and complete all details.

If you are unable to access the computer, please phone us on 0800 438 274 and one of the customer services team will help you to activate the warranty on your garden shed.

***Many thanks, from the Team at Riverlea Group.***